

Worm Gear Screw Jacks NP/I

Housing: Made from aluminium alloy in die-cast version. All sides machined. As standard filled with lubricant.

Gearing: Worm made from ETG100, Gear made from Gbz12.

Self-locking to a certain extend. Vibration, an increase in the spindle pitch or the use of rolling screw elements release the self-locking. In this case, e.g., a brake motor should be included in the system. For lower stroke speeds, worm gear sets with higher transmission ratios can be supplied on request.

Spindle: Material C15, from size 4 C45. On request also available as left-hand, stainless steel or ball screw version.

Travelling nut (version C): Material red brass Rg7.

Protective sleeve: The versions A and B are, unless stated otherwise in the order, supplied with a protective sleeve.

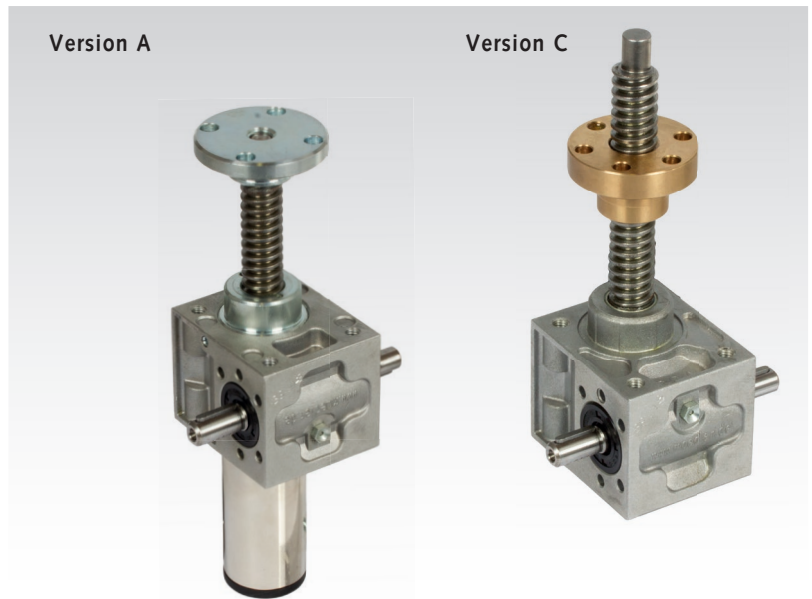

Versions

Version A: With this standard version the threaded spindle moves 1 mm in axial direction with every full rotation of the worm shaft. The spindle has to be secured against twisting.

Version B: Is the same as version A, but inside the gear unit a groove secures the spindle over its entire length against twisting. Thus the load can simply be applied.

Version C: In this version the spindle is fixed to the worm gear. The axial movement is taken over by the threaded nut running outside the gear unit (also 1 mm stroke per full rotation of the worm shaft).

Versions A and B are available with an optional spindle end safety feature. This means the threaded spindle is locked before the safety sleeve is mounted, to limit the stroke in extended position so that

the spindle cannot be screwed out of the gear unit. Attention: this safety feature means the safety sleeve is by about 20 mm longer.

The product numbers below only refer to the basic gear units without spindle. Please ask for the price of the complete unit including spindle and accessories as, e.g., flange plate/travelling nut, bellows or coil spring cover, fastening strips. On request a version for lower stroke speed can be supplied.

Technical Data and Dimensions Tables

Version A: Standard version.

Version B: With anti-rotation guide.

Ordering details: e.g.: Prod. No. Type, Size, Stroke Length, accessories

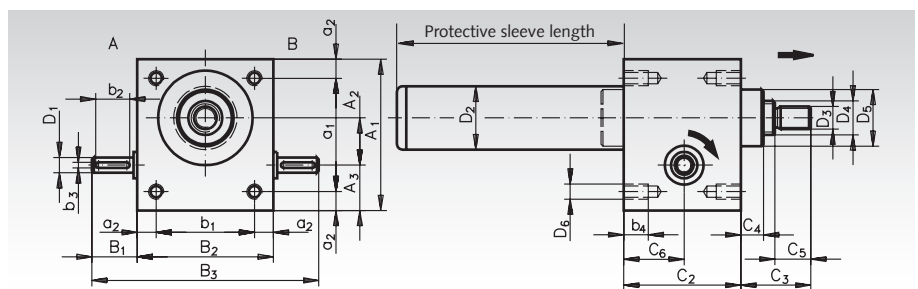

Product No. Vers. A	Product No. Vers. B	Size	max. Stroke Force N	D ₄ Spindle	Efficiency %	Stroke ¹⁾ mm	MD ²⁾ Nm	A ₁ mm	A ₂ mm	A ₃ mm	a ₁ mm	a ₂ mm	B ₁ mm	B ₂ mm	B ₃ mm
475 000 00	475 006 00	0	2500	Tr.16x4	33	1	1,5	64	22,62	17,38	48	8	20	54	94
475 001 00	475 011 00	1	5000	Tr.18x4	33	1	3,2	80	25	24	60	10	24	72	120
475 002 00	475 012 00	2	10000	Tr.20x4	31	1	7	100	32	28	78	11	27,5	85	140
475 003 00	475 013 00	3	25000	Tr.30x6	31	1	16	130	45	31	106	12	45	105	195
475 004 00	475 014 00	4	50000	Tr.40x7	28	1	34	180	63	39	150	15	47,5	145	240

Size	b ₁ mm	b ₂ mm	b ₃ ^{P9} mm	b ₄ mm	C ₂ mm	C ₃ mm	C ₄ mm	C ₅ mm	C ₆ mm	D ₁ ^{H6} mm	D ₂ mm	D ₃ mm	D ₅ mm	D ₆ mm	Protective Sleeve ³⁾ mm	Weight ⁴⁾ kg
0	38	16	3	11	50	30	12	15	25	9	33,5	M10	30	M6	Stroke +20 (45)	0,6
1	52	18	3	13	62	35	12	19	32	10	33,5	M12	30	M8	Stroke +20 (48)	1,2
2	63	20	5	15	75	45	18	19	37	14	42	M14	39	M8	Stroke +30 (55)	2,1
3	81	36	5	15	82	50	23	22	41	16	50	M20	46	M10	Stroke +30 (60)	6
4	115	36	6	16	117	65	32	29	59	20	65	M30	60	M12	Stroke +50 (85)	17

¹⁾ Stroke pro full rotation of the input shaft. ²⁾ Required torque at max. load (only under optimum conditions, with run-in spindle).

³⁾ Length in brackets for version with spindle end safety feature. ⁴⁾ Only weight of gearbox without spindle and accessories.

Technical Data and Dimensions tables

Version C: Travelling nut version.

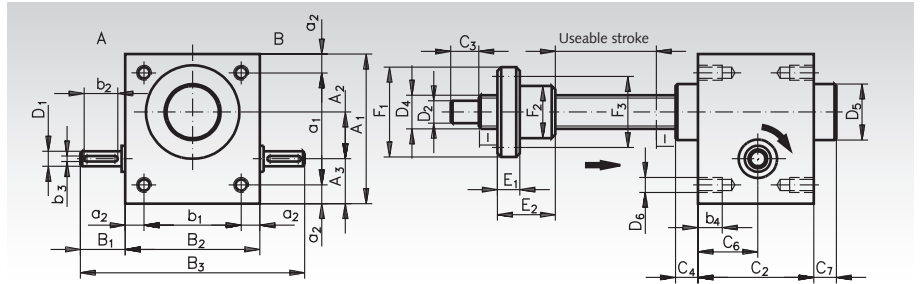

Ordering details: e.g.: Prod. No. Type, Size, Stroke Length, Accessories

Product No. Version C	Size	Max. Stroke Force N	D ₄ Spindle	Degree of Efficiency %	Stroke* mm	MD** Nm	A ₁ mm	A ₂ mm	A ₃ mm	a ₁ mm	a ₂ mm	B ₁ mm	B ₂ mm	B ₃ mm
475 020 00	0	2500	Tr.16x4	33	1	1,5	64	22,62	17,38	48	8	20	54	94
475 021 00	1	5000	Tr.18x4	33	1	3,2	80	25	24	60	10	24	72	120
475 022 00	2	10000	Tr.20x4	31	1	7	100	32	28	78	11	27,5	85	140
475 023 00	3	25000	Tr.30x6	31	1	16	130	45	31	106	12	45	105	195
475 024 00	4	50000	Tr.40x7	28	1	34	180	63	39	150	15	47,5	145	240

Size	b ₁ mm	b ₂ mm	b ₃ ^{P9} mm	b ₄ mm	C ₂ mm	C ₃ mm	C ₄ mm	C ₆ mm	C ₇ mm	I mm	D ₁ ^{h6} mm	D ₂ ^{h6} mm	D ₅ mm	D ₆ mm	E ₁ mm	E ₂ mm	F ₁ mm	F ₂ ^{h9} mm	F ₃ mm	Mounting Bore Travelling Nut	Weight only Gearbox kg
0	38	16	3	11	50	12	12	25	17	10	9	10	30	M6	10	25	45	25	35	6 x Ø6	0,6
1	52	18	3	13	62	15	12	32	17	10	10	12	30	M8	12	44	48	28	38	6 x Ø6	1,2
2	63	20	5	15	75	20	18	37	23	15	14	15	39	M8	12	44	55	32	45	6 x Ø7	2,1
3	81	36	5	15	82	25	23	41	28	20	16	20	46	M10	14	46	62	38	50	6 x Ø7	6
4	115	36	6	16	117	30	32	59	37	25	20	25	60	M12	16	73	95	63	78	6 x Ø9	17

* Stroke pro full rotation of the input shaft.

** Required torque at max. load (only under optimum conditions, with run-in spindle).

Accessories: Flange Plates for Version A and B

Material: Steel 16MnCr5.

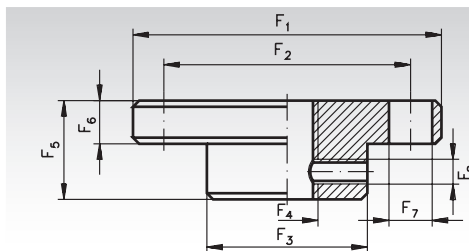
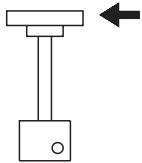

Size	F ₁ mm	F ₂ mm	F ₃ mm	F ₄	F ₅ mm	F ₆ mm	F ₇ mm	F ₈	Weight kg
0	50	40	26	M10	16	7	7	M4	0,1
1	65	48	29	M12	20	7	9	M5	0,2
2	80	60	39	M14	21	8	11	M6	0,3
3	90	67	46	M20	23	10	11	M8	0,6
4	110	85	60	M30	30	15	13	M8	1,3

Accessories: Fastening Strip Sets

Material: Steel St52.

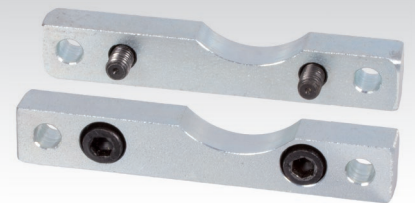
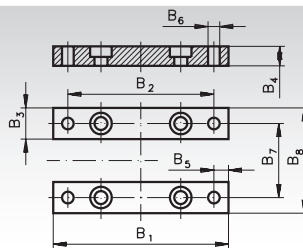
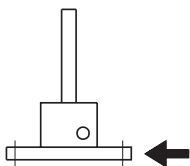

Size	B ₁ mm	B ₂ mm	B ₃ mm	B ₄ mm	B ₅ mm	B ₆ mm	B ₇ mm	B ₈ mm	Weight kg
0	90	75	15	10	7,5	6,5	38	54	0,1
1	120	100	20	10	10	8,5	52	72	0,3
2	140	120	20	10	10	8,5	63	85	0,5
3	170	150	25	12	10	11	81	105	1,0
4	230	204	30	16	13	13,5	115	145	1,8

Accessories For Worm Gear Screw Jacks

Bellows FB (Standard Version) Material: Molerit TH 59 for Worm Gear Screw Jacks Version A + B

Bellows protect the spindles against dirt and reduce the danger of accidents.
Not yet available for size 0.

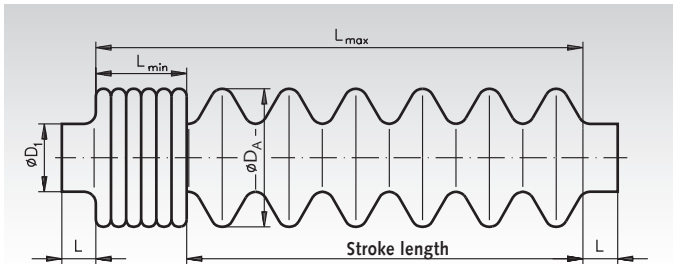

The product number is only required if the bellows is to be delivered separately (not on the gear unit).

Product No.	Size	D ₁ mm	D _A mm	L mm	L _{min} mm	L _{max} mm	max. stroke ¹⁾ mm	Spindle length extension ²⁾ mm	Weight kg
475 001 10	1	30	61	10	40	215	175	36	0,1
475 002 10	2	39	80	15	80	420	340	66	0,1
475 003 10	3	46	90	15	70	420	350	40	0,2
475 004 10	4	60	116	15	120	750	630	120	0,8

¹⁾ For other stroke lengths on request. Alternatively with coil spring cover.

²⁾ With other stroke lengths the dimensions change! Extension has to be calculated for the dimensions C₃ Page 802.

End Switches ES-2 with Roller Push Rod

Optional Accessories for Worm Gear Screw Jacks. For end position switching off. Mounting for screw jacks version A and B in protective tube. Special versions of protective tube and spindle are required for this. The end switches have to be ordered together with the jack.

Ordering Details: e.g.: Worm Gear Screw Jack Type ... with two end switches ES-2 mounted in the protective tube.

Dimensions: Overall length x width x height = 111 x 31 x 33mm.
NC and NO contacts switch simultaneously.

Minimum operating rate 0.01m/s.

Fastening threads M18.

Wiring M20x1.5

Protection class IP65.

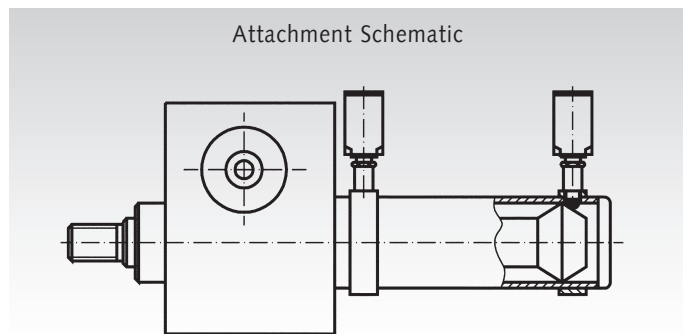
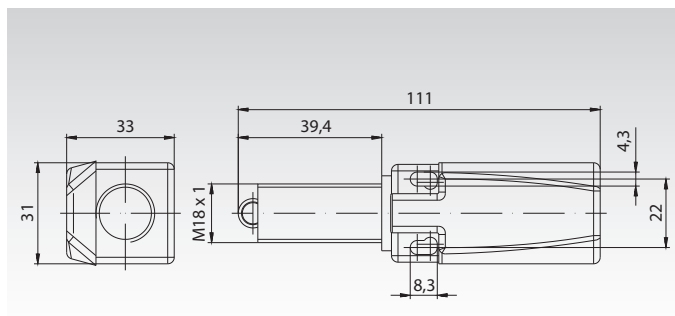
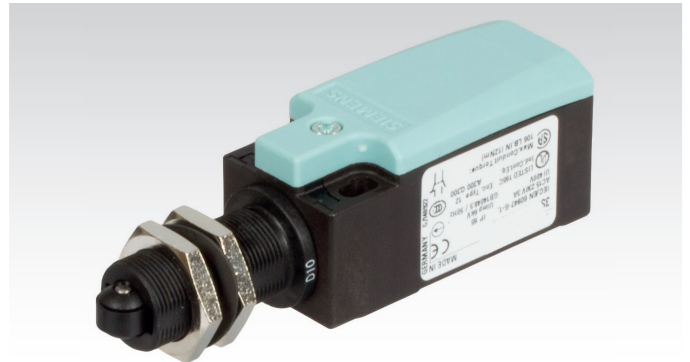

Connecting Shafts Page 806



Frequency Inverters
Page 744



Operating Time Worm Gear Screw Jacks NP/I

The stroke force and stroke speed predetermine which model and size should be chosen. A further decision criterion is the heating up caused by friction. To keep this value within limits, the nominal values must be corrected, using a temperature factor (f_t). The heating-up process depends on the operating time (OT) per time unit (in %).

For stroke speed $V_H = \text{const.}$ applies: $F_{\text{eff}} = F_{\text{Nom.}} \cdot f_t$

For stroke force $F = \text{const.}$ applies:

F_{eff} = effective stroke force
 $F_{\text{Nom.}}$ = Nominal stroke force for model and size

OT- f_t -Diagram Example: OT = 40% = A $f_t = 0,2$

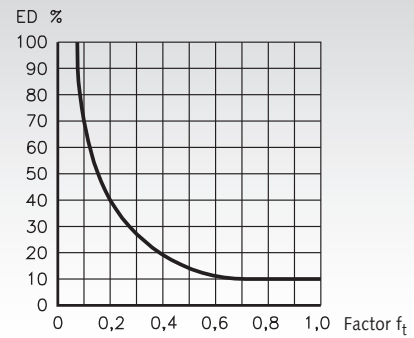

Buckling

Euler-Case 1 $f_k=0.5$

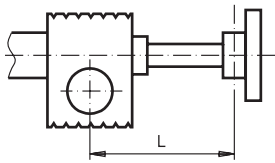

Version A and B
unguided stroke
fixed gear unit

Euler-Case 2 $f_k=1$

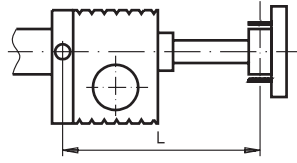

Version A and B
guided stroke
with swivel plate

Euler-Case 3 $f_k=1.4$

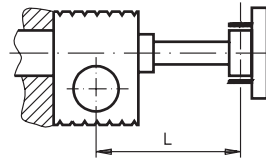

Version A and B
guided stroke
fixed gear unit

Euler-Case 4 $f_k=2$

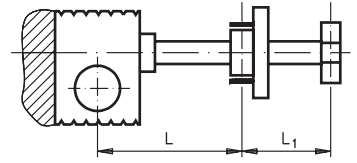

Version C
for small L_1 applies: $f_k = 1.4$
(Euler 3)

Buckling Force P_k [N]

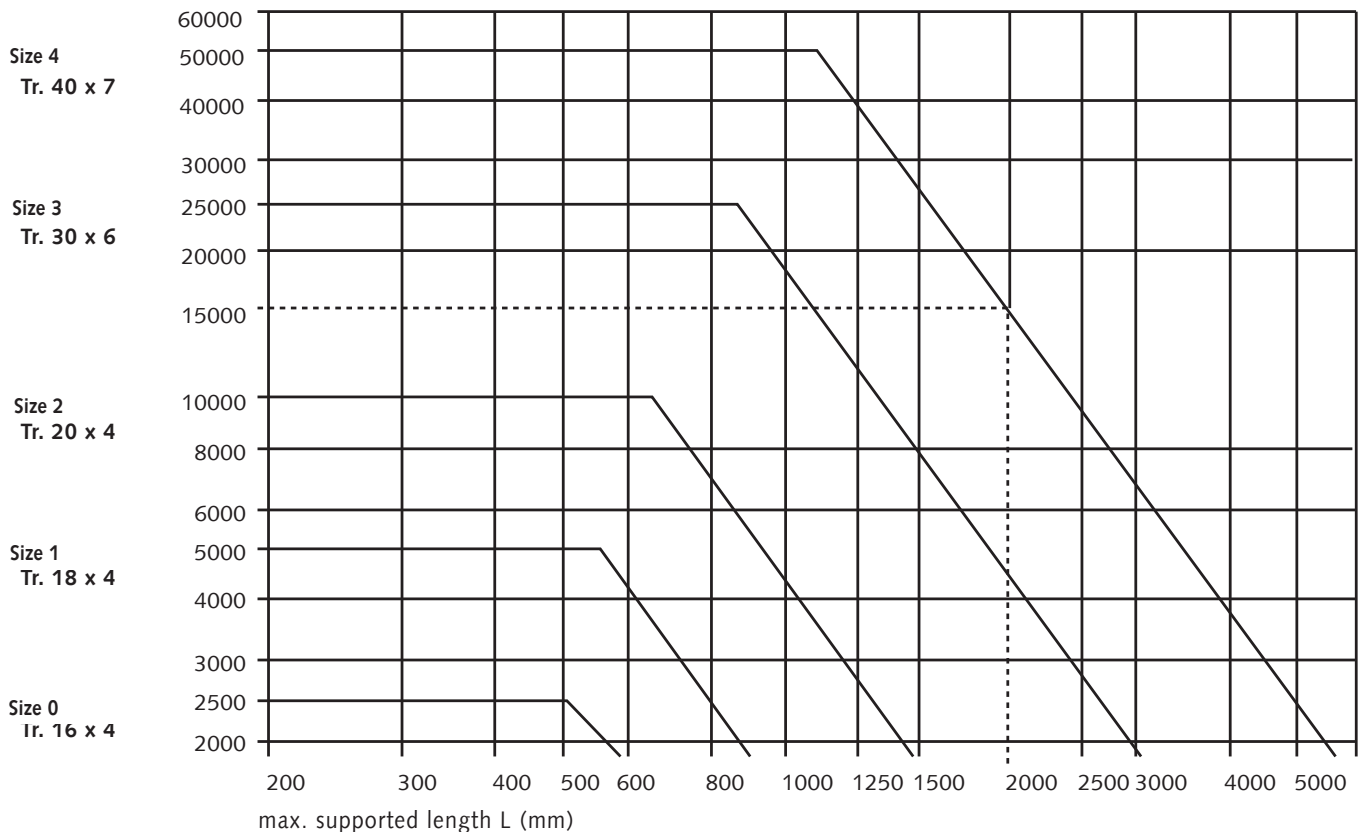

Example

Worm Gear Screw Jacks with Tr 40 x 7 and a spindle length of 2000 mm (stroke + nut + overrun), assumed safety factor $S_k = 4$
 P_k from table: 15,000 N

Mounting set up Euler 1 = $P_{k \text{ perm.}} = 15,000 \times 0.5 \times 1/4$
 Mounting set up Euler 2 = $P_{k \text{ perm.}} = 15,000 \times 1.0 \times 1/4$
 Mounting set up Euler 3 = $P_{k \text{ perm.}} = 15,000 \times 1.4 \times 1/4$
 Mounting set up Euler 4 = $P_{k \text{ perm.}} = 15,000 \times 2.0 \times 1/4$