



Mounting and Operating Instructions

Bevel Gearboxes KEK



Responsible MÄDLER® branches according to German Post Code Areas:

PCA 1, 2 and 3
Subsidiary
MÄDLER GmbH
Brookstieg 16
D-22145 Stapelfeld
Tel. +49 40-60 04 75 10
Fax +49 40-60 04 75 33
hamburg@maedler.de

PCA 0, 4 und 5
Subsidiary
MÄDLER GmbH
Bublitzer Str. 21
D-40599 Düsseldorf
Tel. +49 211-97 47 1 0
Fax +49 211-97 47 1 33
duesseldorf@maedler.de

PCA 6, 7, 8 und 9
Headquarter
MÄDLER GmbH
Tränkestr. 6-8
D-70597 Stuttgart
Tel. +49 711-7 20 95 0
Fax +49 711-7 20 95 33
stuttgart@maedler.de

For Switzerland:

MÄDLER Norm-Antrieb AG
Postbox 74
Güterstr. 6
CH-8245 Feuerthalen
Tel. +41 52-647 40 40
Fax +41 52-647 40 41
info@maedler.ch
www.maedler.ch





Table of contents

1	General information	3
	1.1 Safety and information symbols	3
	1.2 General hazard warnings	3
2	Intended use	3
3	Selection and dimensioning	4
4	Storage	4
5	Mounting	4
	5.1 Mounting instructions	5
	5.2 Mounting the gearbox	5
	5.2 Shaft displacement	5
6	Operating and maintenance	5
7	Wear and replacement	6
8	Spare parts management	6
9	Disposal	6
10	Important information for Ex-zones	6
11	Additional information	6
12	Data sheet	7



1 General information

Carefully read through this installation manual before installing the bevel gearbox. Pay particular attention to the safety instructions! The installation manual is an important document. Store it carefully and in the vicinity of the coupling. The copyright for this installation manual shall remain with MÄDLER GmbH Stuttgart, Germany. The language of the origin manual is German.



1.1 Safety and information symbols

	Danger	Risk of injury to personnel
	Caution	Damage could occur to the machine
	Note	Note regarding important information
	Caution	Notes / instructions on use in Ex zones

1.2 General hazard warnings

  Rotating parts must always be protected by the user from unintentional contact according to the requirements of the law. Moving parts can catch hair, clothing, jewellery, tools or body parts. This could injure or kill persons.

  The housing or shaft endings of the bevel gearbox must not be bored or modified. A breaking housing or shaft could damage machines and injure persons.

  During installation and removal of the MÄDLER® bevel gearbox, make sure that the entire drive train is secured to prevent accidental activation, and that the system is depressurised. Failure to handle rotating parts in the proper manner can cause serious injury. For this reason, the following safety instructions should be read and followed without exception.

- All work on the bevel gearbox should be performed from the perspective of "Safety first".
- Switch off the drive unit before carrying out work on the shaft coupling.
- Secure the drive unit to prevent unintentional activation, e.g. by attaching information signs to the switch-on points or removing the fuse at the power supply.
- Do not reach into the working area of the machine while it is still in operation.
- Protect the rotating parts to prevent accidental touching. Attach the relevant protective devices and covers.

2 Intended use

The bevel gearbox KEK doesn't have the ability to compensate angular, radial and axial displacement caused by manufacturing and assembly tolerances. If such displacements appear, you have to use an appropriate shaft coupling.

You may only install and maintain the gearbox if you

- have carefully read and understood the installation manual
- are authorised and trained to do so.

The gearbox may only be used in accordance with the technical specifications. Unauthorised structural changes to the gearbox are prohibited. We will not accept any liability for damage occurring as a result of this. In the interest further development, we reserve the right to make technical changes. The gearboxes described here correspond with the latest technical standards at the time of publication of this installation manual.

3 Selection and Dimensioning

3.2 Dimensioning

The dimensioning is the responsibility of the user. The gearbox may only be used in accordance with the technical specifications, see the data sheet on the last page of this manual. At drives rotating with high speed, you must pay attention to resonant vibrations. Necessarily, you have to consider the following factors:

Operating Factors

Type of Shock Load

	Type of Drive Unit		
	Electric Motors Steam Turbines Shaftings	4 - 6 Cylinder Combustion Engines	1 - 3 Cylinder Combustion Engines
Weak shock load Low starting torque, uniform operation small light generators, small centrifugal pumps, small blowers, light machine tools, light transmissions	1.0	1.25	1.75
Medium shock load Medium starting torque, slight torque fluctuations larger conveying machinery, large blowers, centrifugal pumps and generators, large machine tools and wood working machines, rapid presses, flower mills and food grinders, shears, punches, grinding machines, washing machines, transmissions	1.25	1.5	2.0
Strong shock load High starting torque, strong shocks, alternating sense of rotation. centrifuges, gang saws, paper calender, roller tables, wet presses, ball and rod mills, heavy rolling mills for metal, rubber rolling mill, reciprocating machines without flywheel, cement mills, stone breakers	1.5	2.0	2.5

4 Storage

- The housing from anodized aluminium is very corrosion resistant. The shafts from normal steel are not protected against corrosion. If the storage will be longer than 6 months, it is recommended to conserve the shafts with oil.
- Provided that storage conditions are favourable, the properties of the gearbox will remain unaltered for up to 5 years.



Damp storage areas are unsuitable.

Make sure that no condensation is produced. A favourable relative humidity level would be below 65 %.

5 Assembly

6.1 Assembly instructions



We recommend checking the dimensional accuracy of the bore and keyway of the corresponding part.



The maximum shaft loads (axial force and radial force), speed and torque must not be exceeded, see data sheet on the last page.



If shaft displacement or shock loads appear, you have to use a flexible coupling. The coupling must be fixed onto the shaft. The hub may not move in axial direction. Note the instructions for the coupling.



It is vital that you pay attention to hazards from ignition sources in areas where there is a risk of explosion!

6.4 Assembling the coupling

Gears with protruding shaft ends should be set up on solid foundations or should be mounted as a flange drive directly on the machine to be driven. The shaft ends have to be aligned very carefully for quiet running and safety during operation. To compensate small assembly errors, we recommend the use of elastic couplings. The couplings should be warmed and then mounted or attached with the aid of a D-centre and a bolt. Do not hammer them on! This will prevent damage to the tooth profiles, roller bearings and locking rings.

Slip-on gears can be directly attached to the shaft of the machine to be driven. They are axially attached with an end plate and bolt. For flange gears it is important that the attachment surface is exactly right angled to the machine shaft's axis. Otherwise the bearings will suffer too much stress and might be damaged. The reaction torque corresponding to the output torque can be compensated for with a torsion bar. Please note: Normally, torsion bars are not used for this shape of gearboxes. They are not available from stock and have to be made as a customized part. The bar should be mounted on the gears' machine side in order to prevent additional bending stresses. Do not mount the gears directly on a foundation plate when the machine shaft is bedded near the gears.

6.4 Displacement types and values



In order to guarantee a long service life for the coupling and to avoid hazards during usage in Ex-zones, the shaft ends must be precisely aligned. The more precisely the gearbox is aligned, the longer its lifetime will be. If shaft displacement or shock loads appear, you have to use a flexible coupling.

6 Operating and Maintenance

6.1 Lubrication

These permanently lubricated drives are factory filled with the correct type and quantity of lubricant, requiring no further attention to the lubrication. Refilling is only necessary, if a significant quantity is lost by leakage. In this case, please ask your responsible MÄDLER® branch for the correct ISO Grade No. and quantity and shaft seals.

6.2 Starting operation

In condition like delivered, the drives are ready to use. There is no ventilation cap, filter or filler cap to be considered.

6.3 Maintenance

All KEK gearboxes require a minimum of maintenance. Only regular checks for leakage are required for these gearboxes with permanent lubrication.

7 Wear and replacement

The ball bearings, bevel gears and shaft seals are wear parts. The wear depends on various operating conditions like running time, number of starts, shaft displacements, number and height of shocks and so on. The shaft seals and ball bearings are DIN parts and are available at MÄDLER® or common industrial suppliers. Worn bevel gears are indicated by large backlash or loud running noise. Then, the complete gearbox should be replaced.

8 Spare parts management



Gearboxes with worn bevel gears must be completely replaced. To avoid unplanned downtimes at important usages, it is recommended to hold a replacement gearbox in stock.

9 Disposal



According to federal law, it may be required to dismount the gearbox for separate disposal. Wear safety glasses and remove the shaft retaining rings. Then the shafts can be pulled out together with the seals, bearings and bevel gears.

10 Important information for Ex-zones



Gearboxes used with other add-on parts could produce heat, sparks and static charges. For use in Ex-zones, there are strictly regulations. Please contact us for the information for EX zone applications.

11 Additional information



The customer bears sole responsibility for all subsequent machining on the gearbox and corresponding parts, which are not performed by MÄDLER®. All claims for warranty are excluded.

12 Data sheet bevel gearboxes KEK

Angular drives with high torques at very low dimensions.
Suitable in a wide variety of applications
7 Sizes. Ratio 1:1.

Housing: Aluminium, silver anodized. Sealed against lubricant leaks, protected against dust. Can be mounted in any position.

Gearing: Bevel gears from steel, surface hardened.

Bearing: Ball bearings with rubber seal RS.

Lubrication: Maintenance free grease lubrication.

Angular backlash: $3^{\circ} \pm 1^{\circ}$.

Operating time: 20% at 5 min.

Life time: 1,000 hours at max. performance at speed 500 min⁻¹ and operating time 20%.

Permiss. operating temperature: -20° to +60°C.

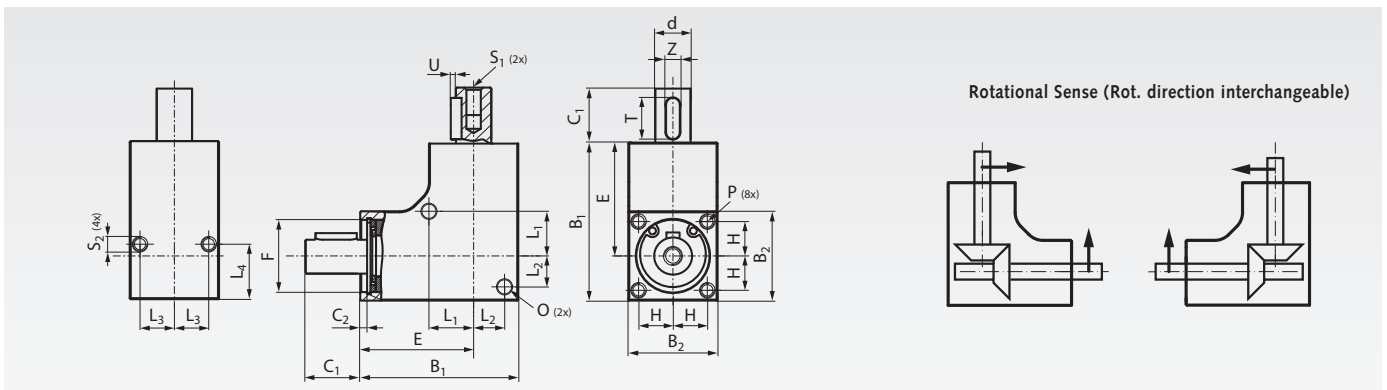

Performance Data

Product No.	Size	Shafts Ø d ^{j6} mm	Ratio i	Permittable Torque at Speed			Permittable Power at Speed			Shaft Load		Weight g
				100 min ⁻¹ Nm	500 min ⁻¹ Nm	1.000 min ⁻¹ Nm	100 min ⁻¹ W	500 min ⁻¹ W	1.000 min ⁻¹ W	F _R * N	F _A ** N	
410 001 01	1	6	1 : 1	0,35	0,1	0,05	3,7	5,2	5,2	60	60	52
410 001 02	2	8	1 : 1	0,75	0,3	0,15	7,9	15,7	15,7	100	100	73
410 001 03	3	10	1 : 1	2,5	1	0,50	26,2	52,4	52,4	120	120	142
410 001 04	4	12	1 : 1	4	1,5	0,75	41,9	78,5	78,5	140	140	189
410 001 05	5	12	1 : 1	5	2	1,0	52	105	105	240	240	268
410 001 06	6	12	1 : 1	8	3	1,5	84	157	157	550	550	330
410 001 07	7	12	1 : 1	10	4	2,0	105	209	209	550	550	395

* Radial load F_R max. (on middle of the Output Shaft) for F_A = 0.

** Axial load F_A max. for F_R = 0.

Dimensiones

Size	B ₁ mm	B ₂ mm	C ₁ mm	C ₂ mm	d ^{j6} mm	E mm	F mm	H mm	L ₁ mm	L ₂ mm	L ₃ mm	L ₄ mm	O mm	P mm	S ₁ mm	S ₂ mm	T mm	U mm	Z mm
1	32	18	12	2,1	6	23	13	6,5	8,5	6	6,5	11	3,1	M3 x 10	M3 x 8	M3 x 6	8	0,8	2
2	35	20	12	2,05	8	25	16	7,5	10	7	7,5	10	3,1	M3 x 10	M3 x 8	M3 x 6	8	0,8	2
3	42	24	16	2,0	10	30	19	9	12	8	9	16	4,1	M4 x 10	M4 x 8	M4 x 8	12	1,5	4
4	46	26	16	2,0	12	33	21	10	13	9	10	16	4,1	M4 x 10	M5 x 8	M4 x 8	12	1,5	4
5	53	30	16	2,1	12	38	24	11	15	11	11	16	4,1	M4 x 10	M5 x 8	M4 x 8	12	1,5	4
6	56	32	16	2,1	12	40	28	12	17	12	12	16	4,1	M4 x 10	M5 x 8	M4 x 8	12	1,5	4
7	60	35	16	2,1	12	42,5	30	13	17,5	13,5	13	16	4,1	M4 x 10	M5 x 8	M4 x 8	12	1,5	4