

Bevel gears Made from Steel, Straight-Tooth System, Ratio 2:1

Material: up to product no. 36105700: 11SMn30+SH (1.0715).
from product no. 36106000: C45.

Tooth quality 8 modelled on DIN 3967 (from module 2).
Up to module 5 with crowned, milled teeth.
From module 6 with planed teeth. Not hardened – not lapped.
Shaft angle = 90°.

The bevel gears only run as a pair at the stated ratio and at the same module.

Ordering Details: e.g.:

1 Pair of Bevel Gears Ratio 2:1 Mod. 0.5 20/40 Teeth =

1 Piece Product No. 360 260 00 and

1 Piece Product No. 360 261 00

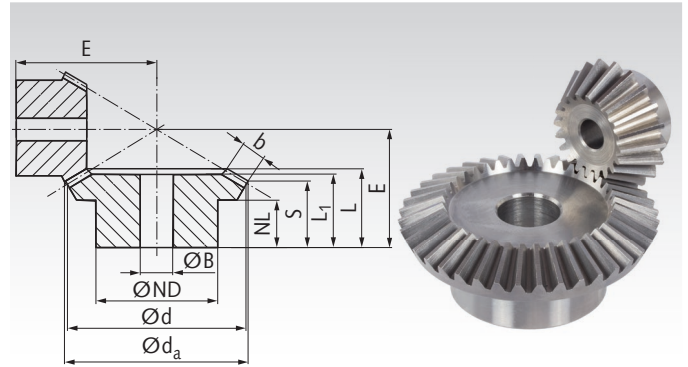

Ratio 2:1

Product No.	Module	Number of teeth	d _a mm	d mm	ND mm	NL mm	L ₁ mm	L mm	S mm	b mm	BH7 mm	E mm	Torque* Nm	Weight g
360 260 00	0,5	20	11,2	10	8	4,0	7,0	7,5	5,0	3	4	14,65	0,017	2
360 261 00	0,5	40	20,3	20	12	5,0	7,5	8,4	7,1	3	4	11,83	0,034	8
360 556 00	1	15	17,4	15	13	6,5	11	11,9	7,6	5	5	22	0,063	10
360 557 00	1	30	30,6	30	20	9,0	13	15,1	13,1	5	5	20	0,126	40
360 756 00	1,5	15	26,1	22,5	18	6,5	13	14,8	8,4	7,6	8	30	0,22	26
360 757 00	1,5	30	45,9	45	30	12,0	18	20,7	17,6	7,6	10	28	0,44	124
360 760 00	1,5	20	33,6	30	20	9,5	19	21,6	12,9	10,1	8	42	0,54	59
360 761 00	1,5	40	60,9	60	40	12,0	19	22,0	17,9	10,1	15	32	1,08	234
361 056 00	2	15	33,7	30	20	7,5	22	23,0	10,9	14	10	40	0,59	58
361 057 00	2	30	61,8	60	40	12,0	24	27,2	21,9	14	15	35	1,18	312
361 060 00	2	20	43,7	40	30	7,5	22	24,0	10,9	15	10	50	1,4	132
361 061 00	2	40	81,8	80	50	18,0	29	32,8	26,9	15	20	45	2,8	593
361 156 00	2,5	15	42,2	37,5	30	15,4	31	33,3	18,6	17	10	55	3,4	160
361 157 00	2,5	30	77,3	75	50	10,0	24	28,1	21,6	17	15	38	6,8	530
361 160 00	2,5	20	54,6	50	30	14,0	34	36,6	19,2	20	10	68	4,3	280
361 161 00	2,5	40	102,3	100	60	15,0	29	33,3	25,3	20	25	48	8,6	970
361 456 00	3	15	50,6	45	30	11,5	33	35,4	16,4	22	10	60	6,1	270
361 457 00	3	30	92,8	90	50	10	26	30,7	22,3	22	20	42	12,2	750
361 460 00	3	20	65,6	60	40	10	33	36,1	14,4	25	15	73	15,2	450
361 461 00	3	40	122,8	120	60	18	34	38,7	28,8	25	25	56	30,4	1400
361 856 00	4	15	67,5	60	40	10	38	41,0	16,9	28	20	75	14,6	410
361 857 00	4	30	123,8	120	60	15	33	39,4	28,8	28	25	55	29,2	1600
361 860 00	4	20	87,4	80	50	13	45	48,0	21,9	30	20	100	35,0	970
361 861 00	4	40	163,7	160	80	20	40	45,7	33,7	30	30	70	70,0	3300
362 156 00	5	15	84,4	75	60	15	50	54,1	21,4	38	20	94	30,2	980
362 157 00	5	30	154,7	150	70	15	40	46,7	32,2	38	30	65	60,4	3030
362 160 00	5	20	109,3	100	60	18	58	62,1	27,3	40	25	125	72,4	1890
362 161 00	5	40	204,7	200	90	20	48	55,6	39,7	40	35	85	144,8	6480
367 360 00	6	20	130,7	120	70	15	58	67	23,6	50	30	139,9	130,0	2960
367 361 00	6	40	245,3	240	100	20	50	58	37,7	50	40	92,3	260,0	9610

* Basis for calculations see page 274.

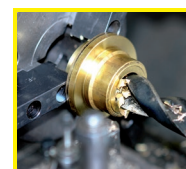

**Reworking within
24h-service possible.
Custom made parts
on request.**