

Leichte Stehlager HM

Werkstoff: Grauguss GG25 (GJL-250).

Bohrungstoleranz: ISO D9.

Mit Bohrung für Einschlagöler.

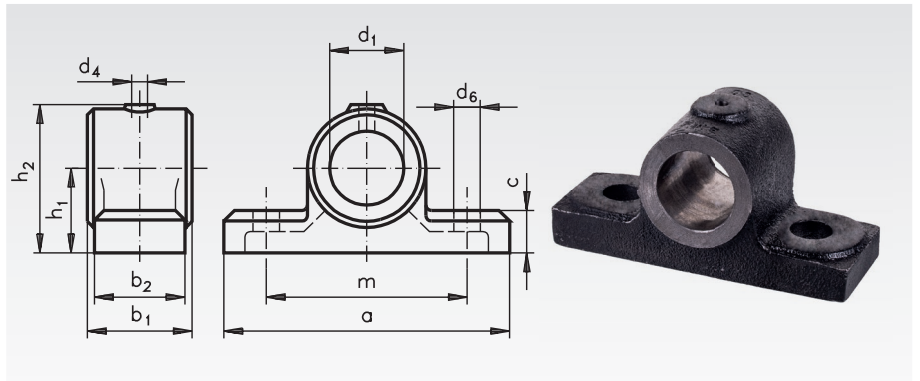

Bestellangaben: z.B.: Art.-Nr. 620 015 00,
Stehlager HM, 15 mm Bohrung

Artikel-Nr.	d ₁ mm	a mm	b ₁ mm	b ₂ mm	c mm	d ₄ mm	d ₆ mm	h ₁ mm	h ₂ mm	m mm	Gewicht kg
620 015 00	15	95	42	35	18,5	5	9 x 14*	30	51	65	0,60
620 020 00	20	95	42	35	18,5	5	9 x 14*	30	51	65	0,50
620 025 00	25	116	50	40	17,5	5	13	35	61	74	0,66
620 030 00	30	116	50	40	17,5	5	15	35	61	74	0,57
620 035 00	35	130	55	45	24	6	17	43	77	85	1,2
620 040 00	40	145	63	50	24	6	18	48	81	95	1,4

* Langloch.

Deckellager DIN 505 Form L, mit Rotguss-Lagerschalen

Werkstoff: Grauguss GG25 (GJL-250).

Lagerschalen: Rg7 (CuSn7Zn4Pb7-C).

Bohrungstoleranz: ISO D10.

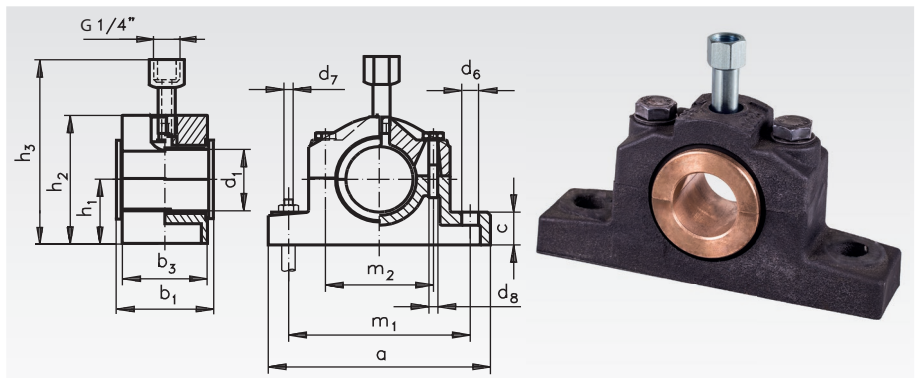

Bestellangaben: z.B.: Art.-Nr. 620 325 00,
Deckellager DIN 505, 25 mm Bohrung

Artikel-Nr.	d ₁ mm	a mm	b ₁ mm	b ₃ mm	c mm	d ₆ mm	d ₇ mm	d ₈ mm	h ₁ mm	h ₂ mm	h ₃ * mm	m ₁ mm	m ₂ mm	Gewicht kg
620 325 00	25	165	45	40	22	15	M12	M10	40	78	116	125	65	1,6
620 330 00	30	165	45	40	22	15	M12	M10	40	78	116	125	65	1,6
620 335 00	35	180	50	45	25	15	M12	M10	50	95	130	140	75	2,3
620 340 00	40	180	50	45	25	15	M12	M10	50	95	130	140	75	2,3
620 345 00	45	210	55	50	30	19	M16	M12	60	114	142	160	90	3,3
620 350 00	50	210	55	50	30	19	M16	M12	60	114	142	160	90	3,3
620 360 00	60	225	60	55	35	19	M16	M12	70	132	162	175	100	4,4
620 370 00	70	270	65	60	40	24	M20	M16	80	154	192	210	120	7,1
620 380 00	80	290	75	70	45	24	M20	M16	90	170	206	230	130	10,2

* ca.-Maß.



Schmierstoffgeber Seite 854.