

Precision Levelling Adjusters

Precision Levellers MN 686.1

Material:

Standard Version: 42CrMo4V, Nr. 1.7225, zinc-plated and blue passivated.

Stainless version: Stainless steel 1.4301 (AISI 304).



- For parallel surfaces.
- Larger overall height with more adjustment travel.
- Without lock nut.

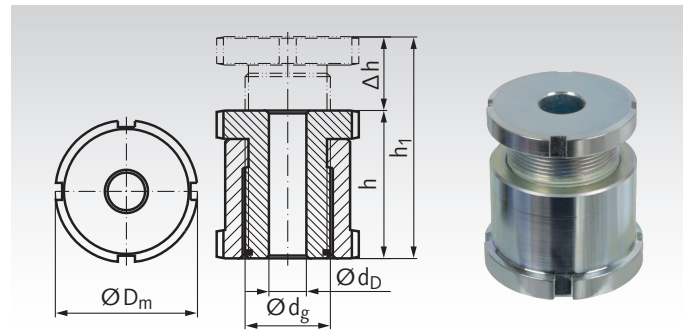

Ordering Details: e.g.: Product No. 686 105 00, MN 686.1 15-6.6 Standard

Product No. standard	Product No. stainless	Type	matching screw	h mm	h1 mm	Δh mm	D _m mm	d _g mm	d _D mm	F _{tot.} * kN	F _{add.} * kN	Weight g
686 105 00	686 991 05	MN 686.1 15-6,6	M6	28	43	15	25	M15x1,0	6,6	40	30,7	66
686 110 00	686 991 10	MN 686.1 20-6,6	M6	35	55	20	32	M20x1,0	6,6	65	55,7	155
686 115 00	686 991 15	MN 686.1 20-9,0	M8	35	55	20	32	M20x1,0	9,0	65	48,0	148
686 120 00	686 991 20	MN 686.1 20-11,0	M10	35	55	20	32	M20x1,0	11,0	65	37,9	138
686 125 00	686 991 25	MN 686.1 30-11,0	M10	42	67	25	45	M30x1,5	11,0	120	92,9	367
686 130 00	686 991 30	MN 686.1 30-13,5	M12	42	67	25	45	M30x1,5	13,5	120	80,4	348
686 135 00	686 991 35	MN 686.1 30-17,5	M16	42	67	25	45	M30x1,5	17,5	120	45,5	319
686 140 00	686 991 40	MN 686.1 40-17,5	M16	54	86	32	58	M40x1,5	17,5	210	136,0	734
686 145 00	686 991 45	MN 686.1 40-22,0	M20	54	86	32	58	M40x1,5	22,0	210	90,0	704
686 150 00	686 991 50	MN 686.1 40-26,0	M24	54	86	32	58	M40x1,5	26,0	210	37,0	647
686 155 00	686 991 55	MN 686.1 50-22,0	M20	66	106	40	70	M50x1,5	22,0	330	210,0	1418
686 160 00	686 991 60	MN 686.1 50-26,0	M24	66	106	40	70	M50x1,5	26,0	330	157,0	1340
686 165 00	686 991 65	MN 686.1 50-33,0	M30	66	106	40	70	M50x1,5	33,0	330	53,0	1175
686 170 00	686 991 70	MN 686.1 60-26,0	M24	76	126	50	80	M60x2,0	26,0	495	322,0	2046
686 175 00	686 991 75	MN 686.1 60-33,0	M30	76	126	50	80	M60x2,0	33,0	495	218,0	1858
686 180 00	686 991 80	MN 686.1 60-39,0	M36	76	126	50	80	M60x2,0	39,0	495	101,0	1640

Other sizes available on request.

Precision Levellers with Lock Nut MN 686.2

Material:

Standard Version: 42CrMo4V, Nr. 1.7225, zinc-plated and blue passivated.

Stainless version: Stainless steel 1.4301 (AISI 304).



- For parallel surfaces.
- Larger overall height with more adjustment travel.
- With lock nut.

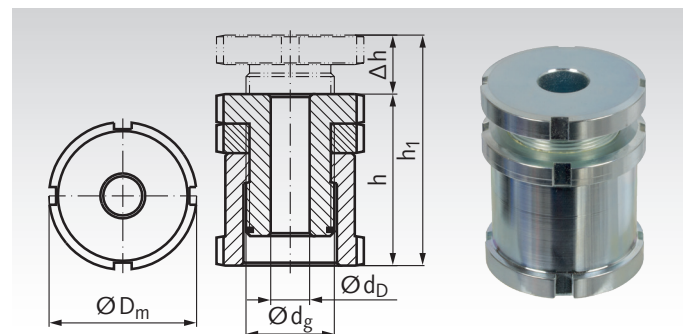

Ordering Details: e.g.: Product No. 686 205 00, MN 686.2 15-6.6 standard

Product No. standard	Product No. stainless	Type	matching screw	h mm	h1 mm	Δh mm	D _m mm	d _g mm	d _D mm	F _{tot.} * kN	F _{add.} * kN	Weight g
686 205 00	686 992 05	MN 686.2 15-6,6	M6	33	43	10	25	M15x1,0	6,6	40	30,7	77
686 210 00	686 992 10	MN 686.2 20-6,6	M6	41	55	14	32	M20x1,0	6,6	65	55,7	174
686 215 00	686 992 15	MN 686.2 20-9,0	M8	41	55	14	32	M20x1,0	9,0	65	48,0	167
686 220 00	686 992 20	MN 686.2 20-11,0	M10	41	55	14	32	M20x1,0	11,0	65	37,9	180
686 225 00	686 992 25	MN 686.2 30-11,0	M10	49	67	18	45	M30x1,5	11,0	120	92,9	407
686 230 00	686 992 30	MN 686.2 30-13,5	M12	49	67	18	45	M30x1,5	13,5	120	80,4	392
686 235 00	686 992 35	MN 686.2 30-17,5	M16	49	67	18	45	M30x1,5	17,5	120	45,5	356
686 240 00	686 992 40	MN 686.2 40-17,5	M16	63	86	23	58	M40x1,5	17,5	210	136,0	847
686 245 00	686 992 45	MN 686.2 40-22,0	M20	63	86	23	58	M40x1,5	22,0	210	90,0	792
686 250 00	686 992 50	MN 686.2 40-26,0	M24	63	86	23	58	M40x1,5	26,0	210	37,0	718
686 255 00	686 992 55	MN 686.2 50-22,0	M20	77	106	29	70	M50x1,5	22,0	330	210,0	1561
686 260 00	686 992 60	MN 686.2 50-26,0	M24	77	106	29	70	M50x1,5	26,0	330	157,0	1478
686 265 00	686 992 65	MN 686.2 50-33,0	M30	77	106	29	70	M50x1,5	33,0	330	53,0	1313
686 270 00	686 992 70	MN 686.2 60-26,0	M24	87	126	39	80	M60x2,0	26,0	495	322,0	2216
686 275 00	686 992 75	MN 686.2 60-33,0	M30	87	126	39	80	M60x2,0	33,0	495	218,0	2016
686 280 00	686 992 80	MN 686.2 60-39,0	M36	87	126	39	80	M60x2,0	39,0	495	101,0	1820

Other sizes on request.

* Values apply to standard version. Values for stainless version, see page 607.

F_{tot.} = max. load. (incl. preload from any mounting screw).

F_{add.} = Load after subtracting the preload of any mounting screw.